

REV.	DESCRIPTION	DATE
A	NEW DRAWING	7/30/2007

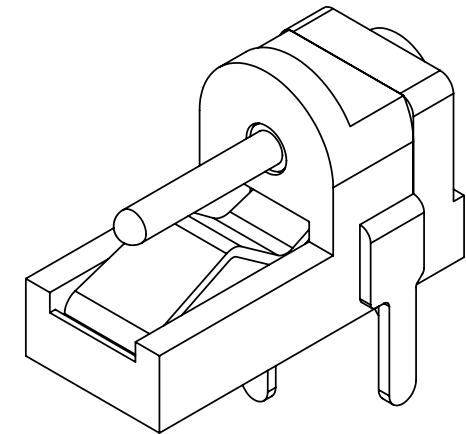

TOLERANCE:
 X.X±0.2mm
 X.XX±0.1mm
 X.XXX±0.05mm

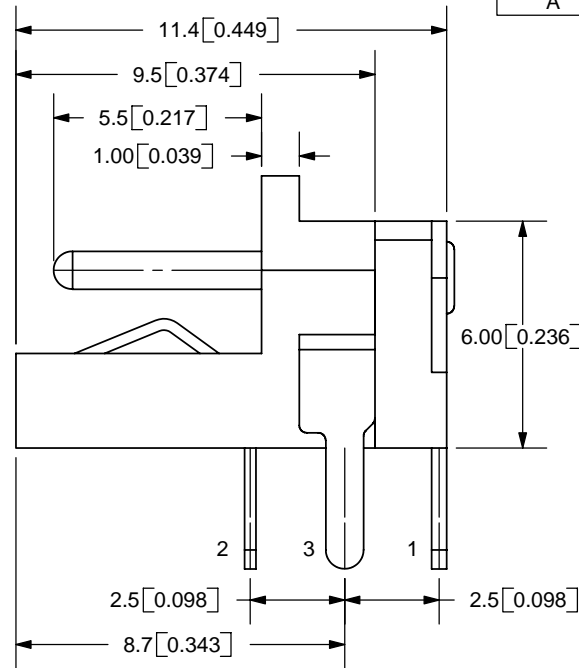
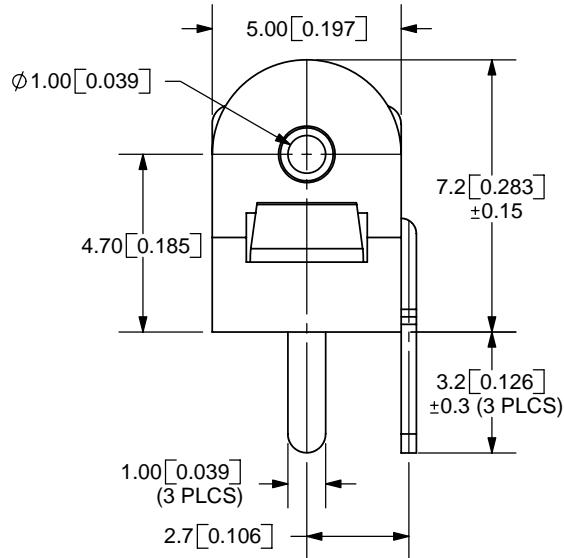
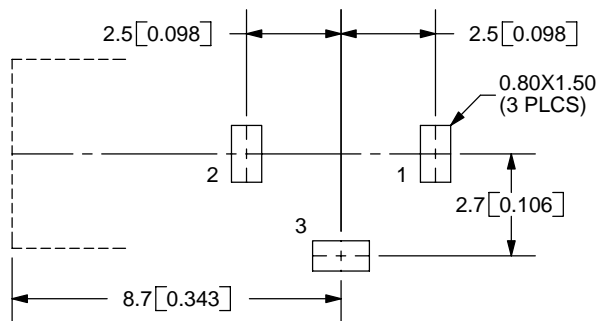

PCB LAYOUT
TOP VIEW

SPECIFICATIONS:
 RATING: 16V DC @ 3.5A
 CONTACT RESISTANCE: 50m OHMS MAX
 INSULATION RESISTANCE: 100M OHMS MIN: 500V DC
 VOLTAGE WITHSTAND: 500V AC R.M.S. FOR 1 MINUTE
 LIFE: 5,000 CYCLES

MODEL NO.	PJ-029CH
SCHEMATIC	

CENTER PIN DIAMETER 1.00mm Dia.

	MATERIAL	PLATING
CENTER PIN	Brass	Nickel
TERMINAL 1	Brass	Silver
TERMINAL 2	Copper Alloy	Silver
TERMINAL 3	Brass	Silver
BODY	PBT	

20050 SW 112th Ave.
 Tualatin, OR 97062
 Phone: 503-612-2300
 800-275-4899
 Fax: 503-612-2383
 Website: www.cui.com

TITLE: DC POWER JACK		REV: A
PART NO. PJ-029CH		UNITS: MM [INCHES]
DRAWN BY: ZRJ	APPROVED BY:	SCALE: 5:1

PC FILE NAME:
PJ-029CH

COPYRIGHT 2007 BY CUI INC.